

S4.1

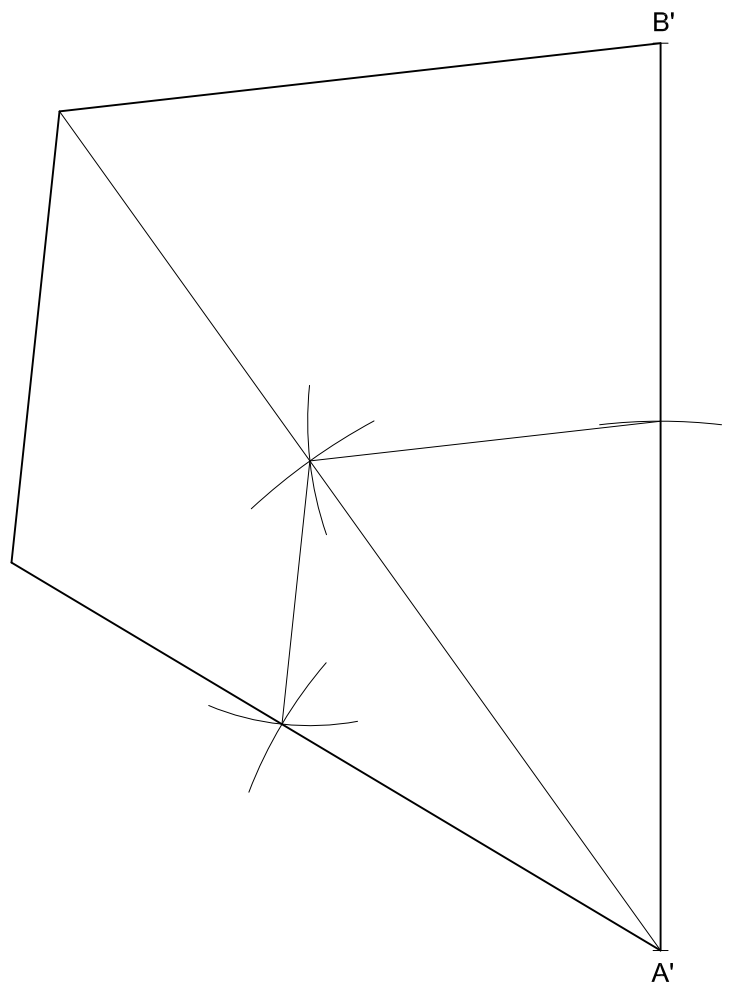
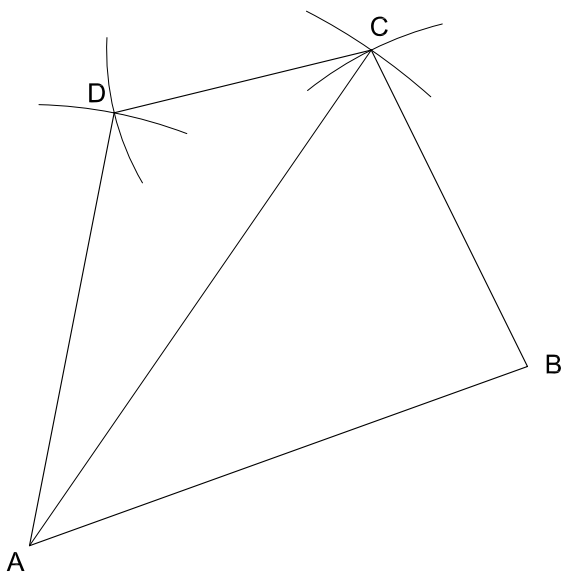

# S4.2A

En el dibuix, la longitud de l'aresta ab-a'b' correspon al segment a'b'', que mesura 4,7 cm.

La longitud real de l'aresta ab-a'b' és de  m.

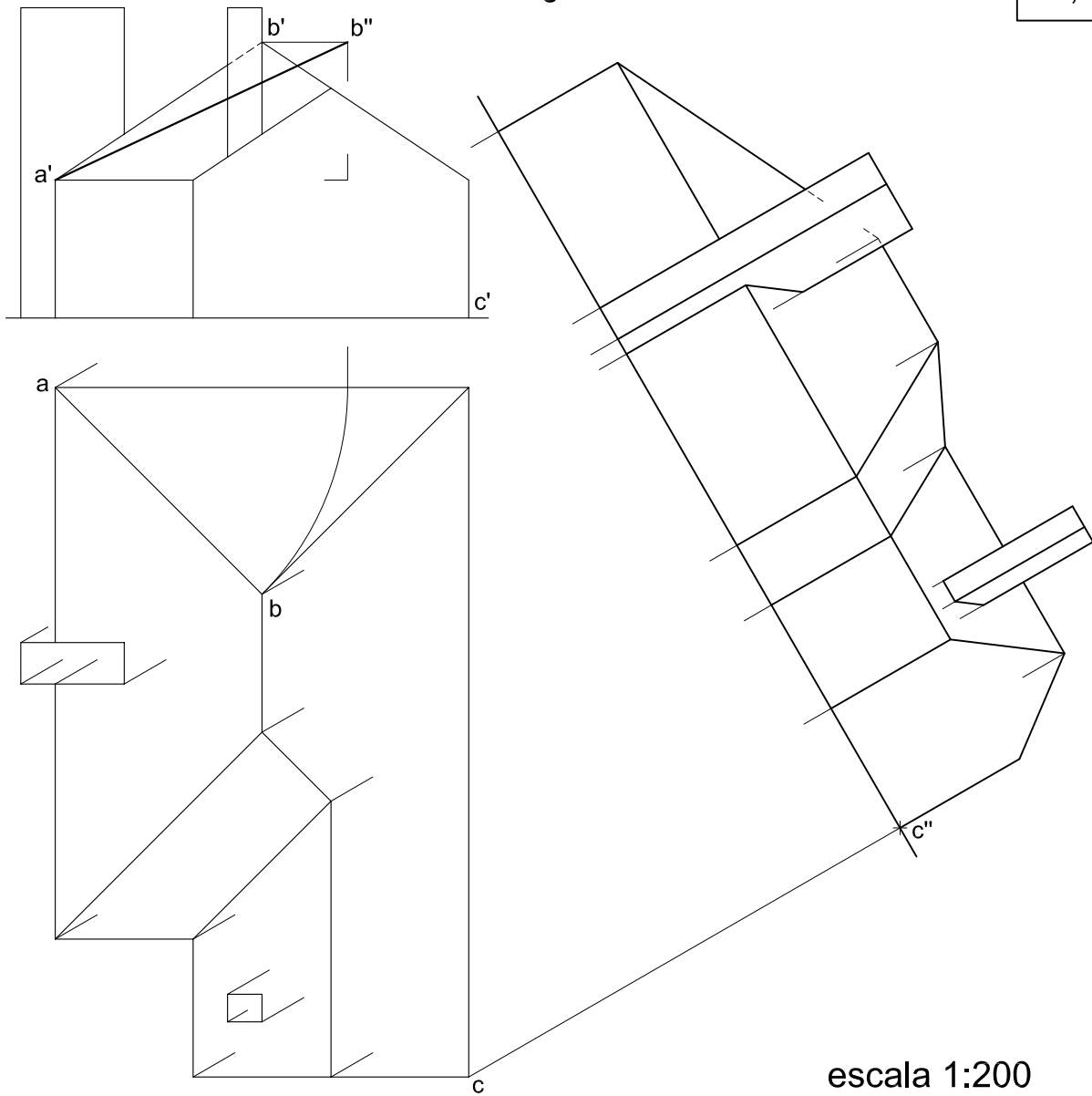

S4.2B

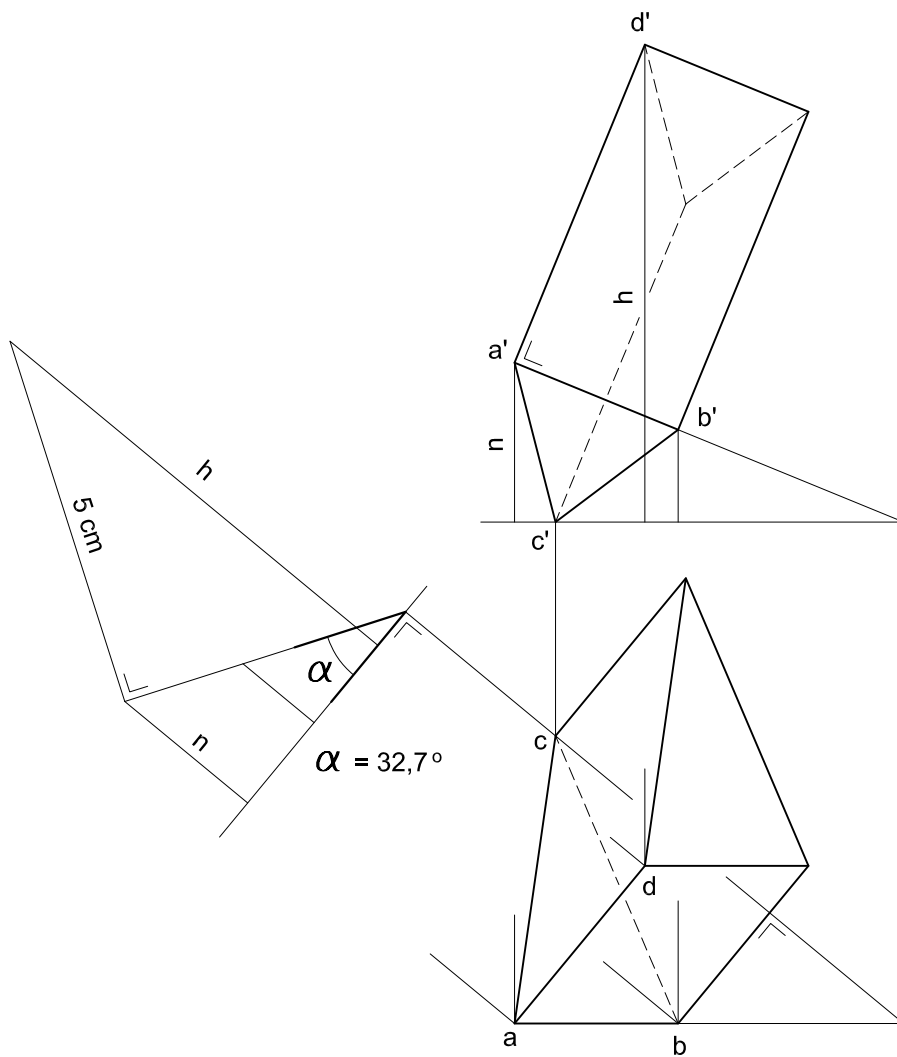

# S4.3A

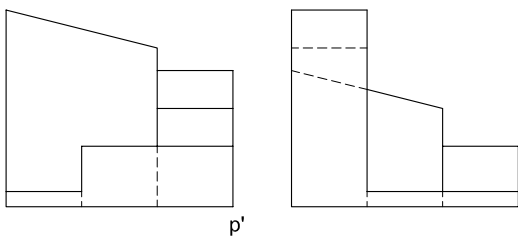
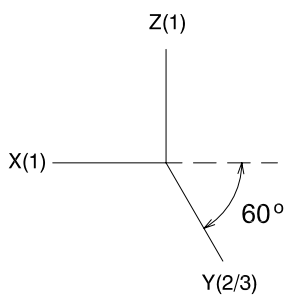

$p'$

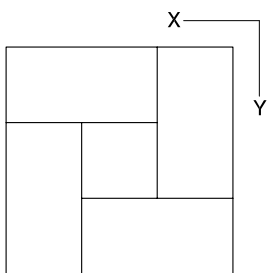

$p$

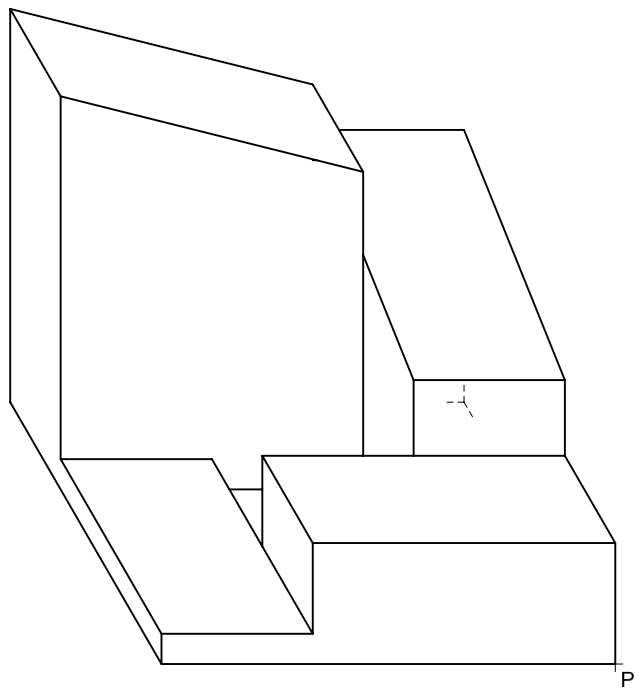

# S4.3B

